

NI 625x Specifications

Specifications listed below are typical at 25 °C unless otherwise noted.

Analog Input

Number of channels

NI 6250/NI 6251 8 differential or
16 single ended

NI 6254/NI 6259 16 differential or
32 single ended

ADC resolution 16 bits

DNL No missing codes
guaranteed

INL Refer to the *AI
Absolute Accuracy
Table*

Sampling rate

Maximum 1.25 MS/s
single channel,
1.00 MS/s
multi-channel

Minimum 0 S/s

Timing accuracy 50 ppm of
sample rate

Timing resolution 50 ns

Input coupling DC

Input range ± 10 V, ± 5 V, ± 2 V,
 ± 1 V, ± 0.5 V,
 ± 0.2 V, ± 0.1 V

Maximum working voltage for analog inputs
(signal + common mode) ± 11 V of AI GND

CMRR (DC to 60 Hz) 100 dB

Input impedance

AI+ to AI GND >10 G Ω in parallel
with 100 pF

AI- to AI GND >10 G Ω in parallel
with 100 pF

Input bias current ± 100 pA

Crosstalk (at 100 kHz)

Adjacent channels -75 dB

Non-adjacent channels -95 dB

Small signal bandwidth

(-3 dB) 1.7 MHz

Input FIFO size 4,095 samples

Scan list memory 4,095 entries

Data transfers DMA
(scatter-gather),
interrupts,
programmed I/O

Overvoltage protection

(AI $<0..31>$, AI SENSE, AI SENSE 2)

Device on ± 25 V for up to
four AI pins

Device off ± 15 V for up to
four AI pins

Input current during

overvoltage condition ± 20 mA max/AI pin

Settling Time for Multichannel Measurements

Range	± 60 ppm of Step (± 4 LSB for Full Scale Step)	± 15 ppm of Step (± 1 LSB for Full Scale Step)
± 10 V, ± 5 V, ± 2 V, ± 1 V	1 μ s	1.5 μ s
± 0.5 V	1.5 μ s	2 μ s
± 0.2 V, ± 0.1 V	2 μ s	8 μ s

Typical Performance Graphs

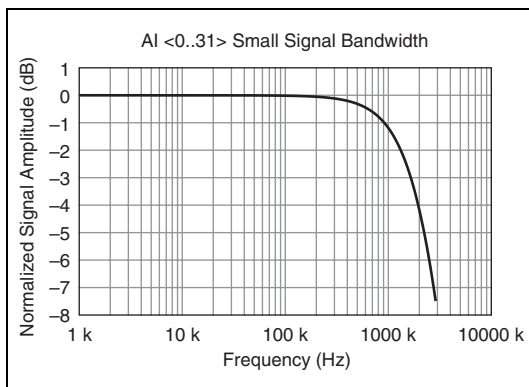
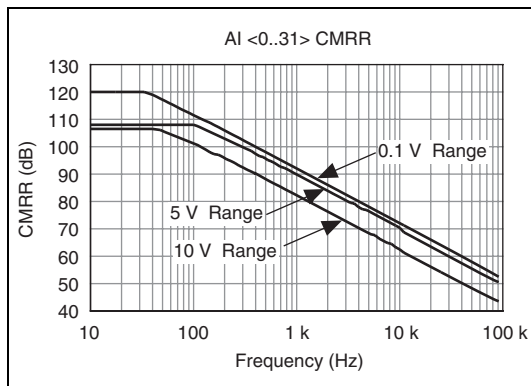
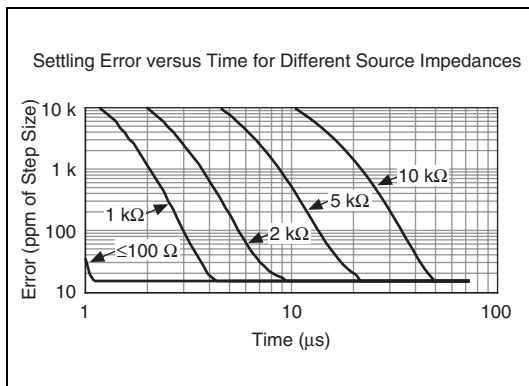

Analog Triggers

Number of triggers	1
Source	
NI 6250/NI 6251	AI <0..15>, APFI 0
NI 6254/NI 6259	AI <0..31>, APFI <0..1>
Functions	Start Trigger, Reference Trigger, Pause Trigger, Sample Clock, Convert Clock, Sample Clock Timebase
Source level	
(AI <0..31>)	±full scale
(APFI <0..1>)	±10 V
Resolution	10 bits, 1 in 1,024
Modes	Level triggering, level triggering with hysteresis, window triggering
Bandwidth (–3 dB)	
AI <0..31>	3.4 MHz
APFI <0..1>	3.9 MHz
Accuracy	±1%
APFI <0..1> characteristics	
Input impedance	10 kΩ
Coupling	DC
Protection	
Power on	±30 V
Power off	±15 V

Analog Output

Number of channels	
NI 6250	0
NI 6251	2
NI 6254	0
NI 6259	4
DAC resolution	16 bits
DNL	±1 LSB
Monotonicity	16 bit guaranteed
Accuracy	Refer to the <i>AO Absolute Accuracy Table</i>
Maximum update rate	
1 channel	2.86 MS/s
2 channels	2.00 MS/s
3 channels	1.54 MS/s
4 channels	1.25 MS/s
Timing accuracy	50 ppm of sample rate
Timing resolution	50 ns
Output range	±10 V, ±5 V, ±external reference on APFI <0..1>
Output coupling	DC
Output impedance	0.2 Ω
Output current drive	±5 mA
Overdrive protection	±25 V
Overdrive current	20 mA
Power-on state	±5 mV
Power-on glitch	1.2 V peak for 12 ms
Output FIFO size	8,191 samples shared among channels used

Data transfersDMA
(Scatter-gather),
interrupts,
programmed I/O

AO waveform modes:

- Non-periodic waveform
- Periodic waveform regeneration mode from onboard FIFO
- Period waveform regeneration from host buffer including dynamic update

Settling time, full scale step
15 ppm (1 LSB)2 μ s

Slew rate20 V/ μ s

Glitch energy at midscale transition,
 \pm 10 V range

Magnitude.....10 mV

Duration.....1 μ s

External Reference

APFI <0..1> characteristics

Input impedance10 k Ω

CouplingDC

Protection

Power on \pm 30 V

Power off \pm 15 V

Range \pm 11 V

Slew rate20 V/ μ s

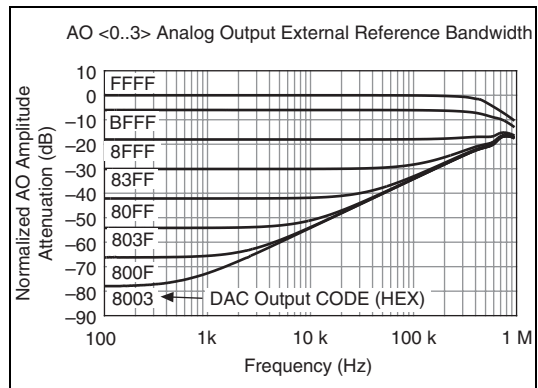

Calibration (AI and AO)

Recommended

warm-up time 15 minutes

Calibration interval 2 years

AI Absolute Accuracy Table

Nominal Range		Residual Gain Error (ppm of Reading)	Gain Tempco (ppm/°C)	Reference Tempco	Residual Offset Error (ppm of Range)	Offset Tempco (ppm of Range/°C)	INL Error (ppm of Range)	Random Noise, σ (μ V rms)	Absolute Accuracy at Full Scale ¹ (μ V)	Sensitivity ² (μ V)
Positive Full Scale	Negative Full Scale									
10	-10	60	13	1	20	21	60	280	1,920	112.0
5	-5	70	13	1	20	21	60	140	1,010	56.0
2	-2	70	13	1	20	24	60	57	410	22.8
1	-1	80	13	1	20	27	60	32	220	12.8
0.5	-0.5	90	13	1	40	34	60	21	130	8.4
0.2	-0.2	130	13	1	80	55	60	16	74	6.4
0.1	-0.1	150	13	1	150	90	60	15	52	6.0

AbsoluteAccuracy = Reading · (GainError) + Range · (OffsetError) + NoiseUncertainty

GainError = ResidualGainError + GainTempco · (TempChangeFromLastInternalCal) + ReferenceTempco · (TempChangeFromLastExternalCal)

OffsetError = ResidualOffsetError + OffsetTempco · (TempChangeFromLastInternalCal) + INL_Error

NoiseUncertainty = $\frac{\text{RandomNoise} \cdot 3}{\sqrt{100}}$ For a coverage factor of 3 σ and averaging 100 points.

¹ Absolute accuracy at full scale on the analog input channels is determined using the following assumptions:

TempChangeFromLastExternalCal = 10 °C

TempChangeFromLastInternalCal = 1 °C

number_of_readings = 100

CoverageFactor = 3 σ

For example, on the 10 V range, the absolute accuracy at full scale is as follows:

GainError = 60 ppm + 13 ppm · 1 + 1 ppm · 10

OffsetError = 20 ppm + 21 ppm · 1 + 60 ppm

NoiseUncertainty = $\frac{275 \mu\text{V} \cdot 3}{\sqrt{100}}$ NoiseUncertainty = 83 μ V

AbsoluteAccuracy = 10 V · (GainError) + 10 V · (OffsetError) + NoiseUncertainty

AbsoluteAccuracy = 1920 μ V

² Sensitivity is the smallest voltage change that can be detected. It is a function of noise.

AO Absolute Accuracy Table

Positive Full Scale	Nominal Range		Residual Gain Error (ppm of Reading)	Gain Tempco (ppm/°C)	Reference Tempco	Residual Offset Error (ppm of Range)	Offset Tempco (ppm of Range/°C)	INL Error (ppm of Range)	Absolute Accuracy at Full Scale ¹ (µV)
	Negative Full Scale								
10	-10		75	17	1	40	2	64	2,080
5	-5		85	8	1	40	2	64	1,045

¹ Absolute Accuracy at full scale numbers is valid immediately following internal calibration and assumes the device is operating within 10 °C of the last external calibration.

$AbsoluteAccuracy = OutputValue \cdot (GainError) + Range \cdot (OffsetError)$
 $GainError = ResidualGainError + GainTempco \cdot (TempChangeFromLastInternalCal) + ReferenceTempco \cdot (TempChangeFromLastExternalCal)$
 $OffsetError = ResidualOffsetError + AOffsetTempco \cdot (TempChangeFromLastInternalCal) + INL_Error$

Digital I/O/PFI

Static Characteristics

Number of channels

NI 6250/NI 6251 24 total,
8 (P0.<0..7>),
16 (PFI <0..15>/
P1/P2)

NI 6254/NI 6259 48 total,
32 (P0.<0..31>),
16 (PFI <0..15>/
P1/P2)

Ground reference D GND

Direction control Each terminal
individually
programmable as
input or output

Pull-down resistor 50 kΩ to 75 kΩ

Input voltage protection¹ ±20 V on up to
two pins

Waveform Characteristics (Port 0 Only)

Terminals used

NI 6250/NI 6251 Port 0 (P0.<0..7>)

NI 6254/NI 6259 Port 0 (P0.<0..31>)

Port/sample size

NI 6250/NI 6251 Up to 8 bits

NI 6254/NI 6259 Up to 32 bits

Waveform generation

(DO) FIFO 2,047 samples

Waveform acquisition

(DI) FIFO 2,047 samples

DO or DI Sample

Clock frequency 0 to 10 MHz

DO or DI Sample

Clock source Any PFI, RTSI,
AI Sample or
Convert Clock,
AO Sample Clock,
DI change event,
Ctr *n* Internal
Output, and many
other signals

PFI/Port 1/Port 2 Functionality

Functionality Static digital input,
Static digital output,
timing input,
timing output

Timing output sources Many AI, AO,
counter, DI,
DO timing signals

Debounce filter settings 125 ns, 6.425 μs,
2.54 ms, disable;
high and low
transitions;
selectable per input

¹ Stresses beyond those listed under *Input voltage protection* may cause permanent damage to the device.

Recommended Operation Conditions

Level	Min	Max
Input high voltage (V_{IH})	2.2 V	5.25 V
Input low voltage (V_{IL})	0 V	0.8 V
Output high current (I_{OH})		
P0.<0..31>	—	-24 mA
PFI <0..15>/ P1/P2	—	-16 mA
Output low current (I_{OL})		
P0.<0..31>	—	24 mA
PFI <0..15>/P1/P2	—	16 mA

Electrical Characteristics

Level	Min	Max
Positive-going threshold (V_{T+})	—	2.2 V
Negative-going threshold (V_{T-})	0.8 V	—
Delta VT hysteresis ($V_{T+} - V_{T-}$)	0.2 V	—
I_{IL} input low current ($V_{in} = 0$ V)	—	-10 μ A
I_{IH} input high current ($V_{in} = 5$ V)	—	250 μ A

Digital I/O Characteristics

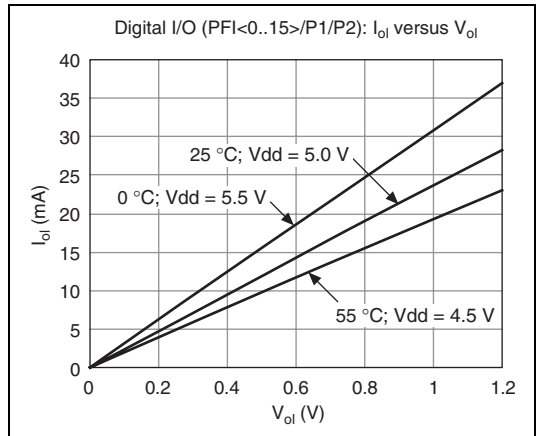
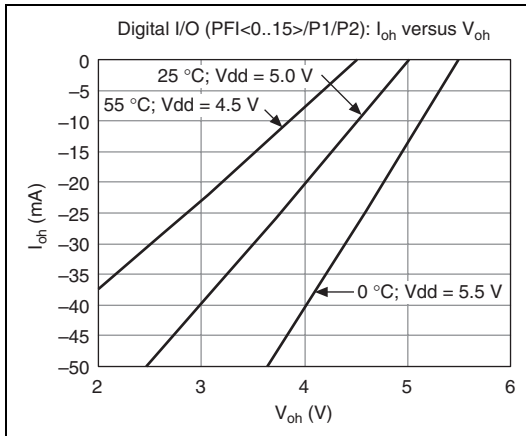
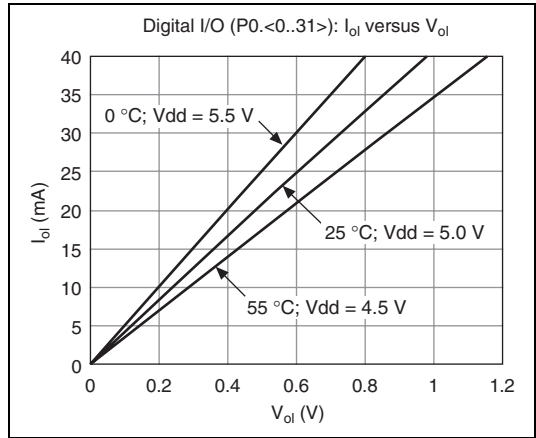
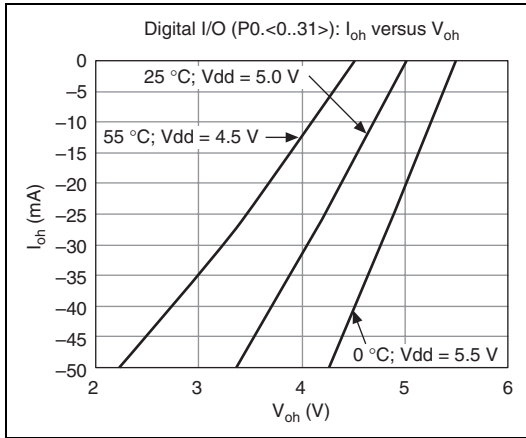

General-Purpose Counter/Timers

Number of counter/timers2
Resolution32 bits
Counter measurementsEdge counting, pulse, semi-period, period, two-edge separation
Position measurementsX1, X2, X4 quadrature encoding with Channel Z reloading; two-pulse encoding
Output applicationsPulse, pulse train with dynamic updates, frequency division, equivalent time sampling
Internal base clocks80 MHz, 20 MHz, 0.1 MHz
External base clock frequency0 MHz to 20 MHz
Base clock accuracy50 ppm
InputsGate, Source, HW_Arm, Aux, A, B, Z, Up_Down
Routing options for inputs	...Any PFI, RTSI, PXI_TRIG, PXI_STAR, analog trigger, many internal signals
FIFO2 samples
Data transfersDedicated scatter-gather DMA controller for each counter/timer; interrupts; programmed I/O

Frequency Generator

Number of channels 1
Base clocks 10 MHz, 100 kHz
Divisors 1 to 16
Base clock accuracy 50 ppm
Output	can be available on any PFI or RTSI terminal.

Phase-Locked Loop (PLL)

Number of PLLs 1
Reference signal PXI_STAR, PXI_CLK10, RTSI <0..7>
Output of PLL 80 MHz Timebase; other signals derived from 80 MHz Timebase including 20 MHz and 100 kHz Timebases

External Digital Triggers

Source Any PFI, RTSI, PXI_TRIG, PXI_STAR
Polarity Software-selectable for most signals
Analog input function Start Trigger, Reference Trigger, Pause Trigger, Sample Clock, Convert Clock, Sample Clock Timebase
Analog output function Start Trigger, Pause Trigger, Sample Clock, Sample Clock Timebase

Counter/timer functions..... Gate, Source,
HW_Arm, Aux,
A, B, Z, Up_Down

Digital waveform generation
(DO) function Sample Clock

Digital waveform acquisition
(DI) function..... Sample Clock

Device-To-Device Trigger Bus

PCI devices..... RTSI <0..7>¹

PXI devices PXI_TRIG <0..7>,
PXI_STAR

Output selections 10 MHz Clock;
frequency generator
output; many
internal signals

Debounce filter settings..... 125 ns, 6.425 μ s,
2.54 ms, disable;
high and low
transitions;
selectable per input

Bus Interface

PCI or PXI..... 3.3 V or 5 V signal
environment

DMA channels..... 6, analog input,
analog output,
digital input,
digital output,
counter/timer 0,
counter/timer 1

Power Requirements

Current draw from bus during no-load condition

+5 V 0.03 A

+3.3 V 0.725 A

+12 V 0.35 A

Current draw from bus during AI and AO
overvoltage condition

+5 V 0.03 A

+3.3 V 1.2 A

+12 V 0.38 A

Power available from

+5 V terminal..... 1 A max, each
connector, with
self-resetting fuse

Other power limit for

PXI devices..... Current drawn from
+5 V terminals and
all P0/PFI/P1/P2
terminals should not
exceed 2 A

Physical Requirements

Printed circuit board dimensions

NI PCI 6250/6251/
6254/6259

9.7 cm \times 15.5 cm
(3.8 in. \times 6.1 in.)

NI PXI 6250/6251/
6254/6259

Standard 3U PXI

I/O connector

NI 6250/NI 6251 1 68-pin VHDCI

NI 6254/NI 6259 2 68-pin VHDCI

¹ In other sections of this document, *RTSI* refers to *RTSI <0..7>* for PCI devices or *PXI_TRIG <0..7>* for PXI devices.

Maximum Working Voltage¹

NI 6250/NI 6251/NI 6254/NI 6259

Channel to earth 11 V, Installation
Category I

Channel to channel 11 V, Installation
Category I

Environmental

Operating temperature 0 to 55 °C

Storage temperature -20 to 70 °C

Humidity 10 to 90% RH,
noncondensing

Maximum altitude 2,000 m

Pollution Degree
(indoor use only) 2

Safety

This product is designed to meet the requirements of the following standards of safety for electrical equipment for measurement, control, and laboratory use:

- IEC 61010-1, EN 61010-1
- UL 61010-1
- CAN/CSA C22.2 No. 61010-1



Note For UL and other safety certifications, refer to the product label, or visit ni.com/certification, search by model number or product line, and click the appropriate link in the Certification column.

Electromagnetic Compatibility

Emissions EN 55011 Class A at
10 m FCC Part 15A
above 1 GHz

Immunity EN 61326:1997 +
A2:2001, Table 1

CE, C-Tick, and FCC Part 15 (Class A)
Compliant



Note For EMC compliance, operate this device with shielded cabling.

CE Compliance

This product meets the essential requirements of applicable European Directives, as amended for CE marking, as follows:

Low-Voltage Directive
(safety) 73/23/EEC

Electromagnetic Compatibility
Directive (EMC) 89/336/EEC



Note Refer to the Declaration of Conformity (DoC) for this product for any additional regulatory compliance information. To obtain the DoC for this product, visit ni.com/certification, search by model number or product line, and click the appropriate link in the Certification column.

¹ *Maximum working voltage* refers to the signal voltage plus the common-mode voltage.

